

國小男一.二.三.四年級個人預賽，A~E組取兩名F組取三名晉級

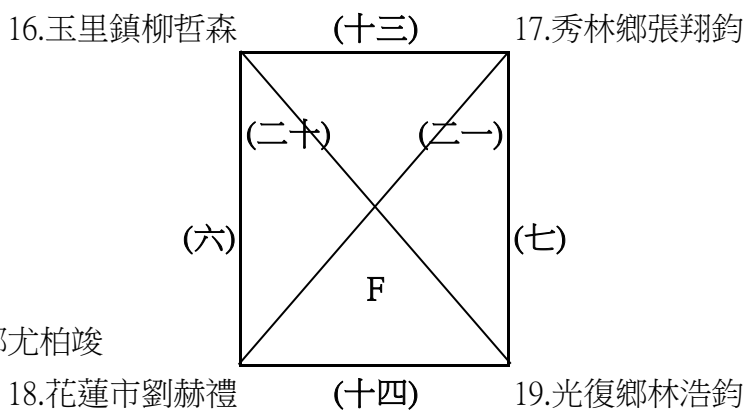

國小男一.二.三.四年級個人決賽(單敗淘汰)

- 第一名：
- 第二名：
- 第三名：
- 第四名：
- 第五名：
- 第五名：
- 第五名：
- 第五名：

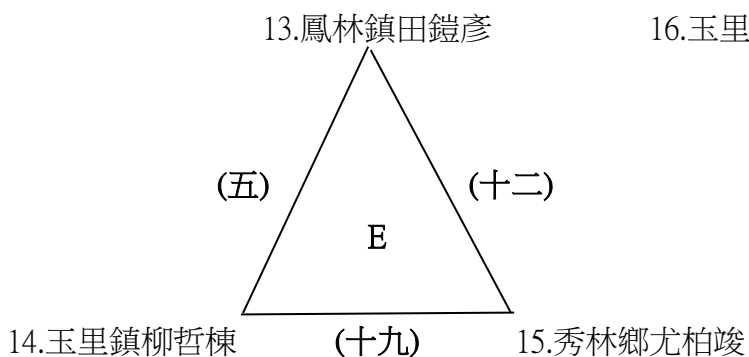
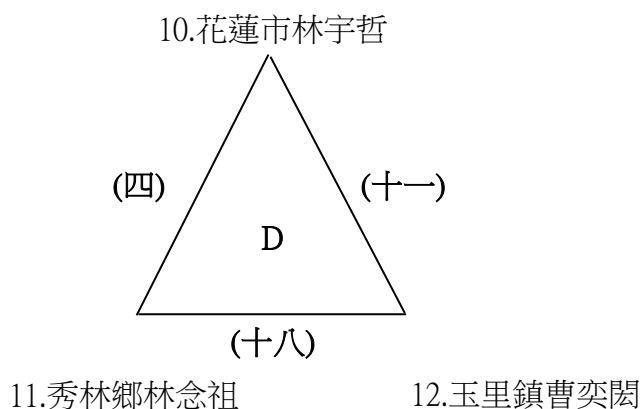
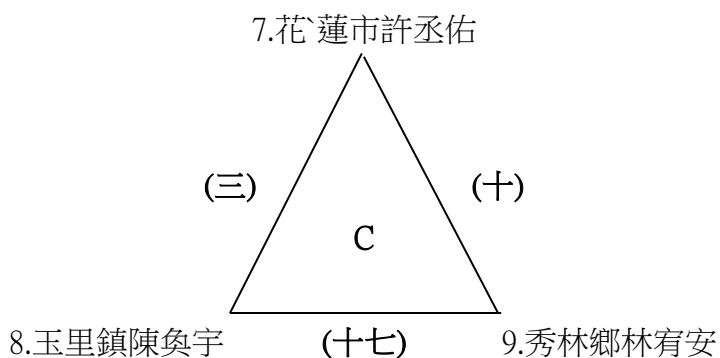
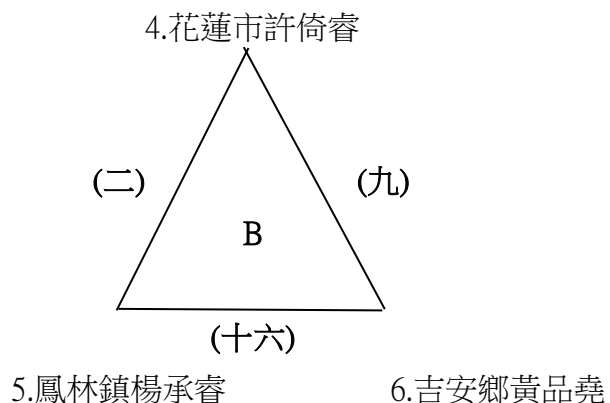
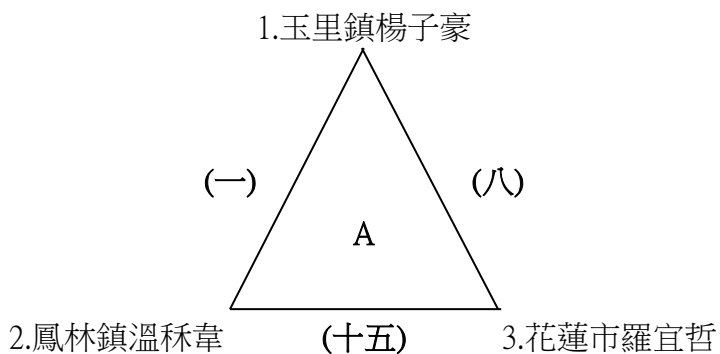
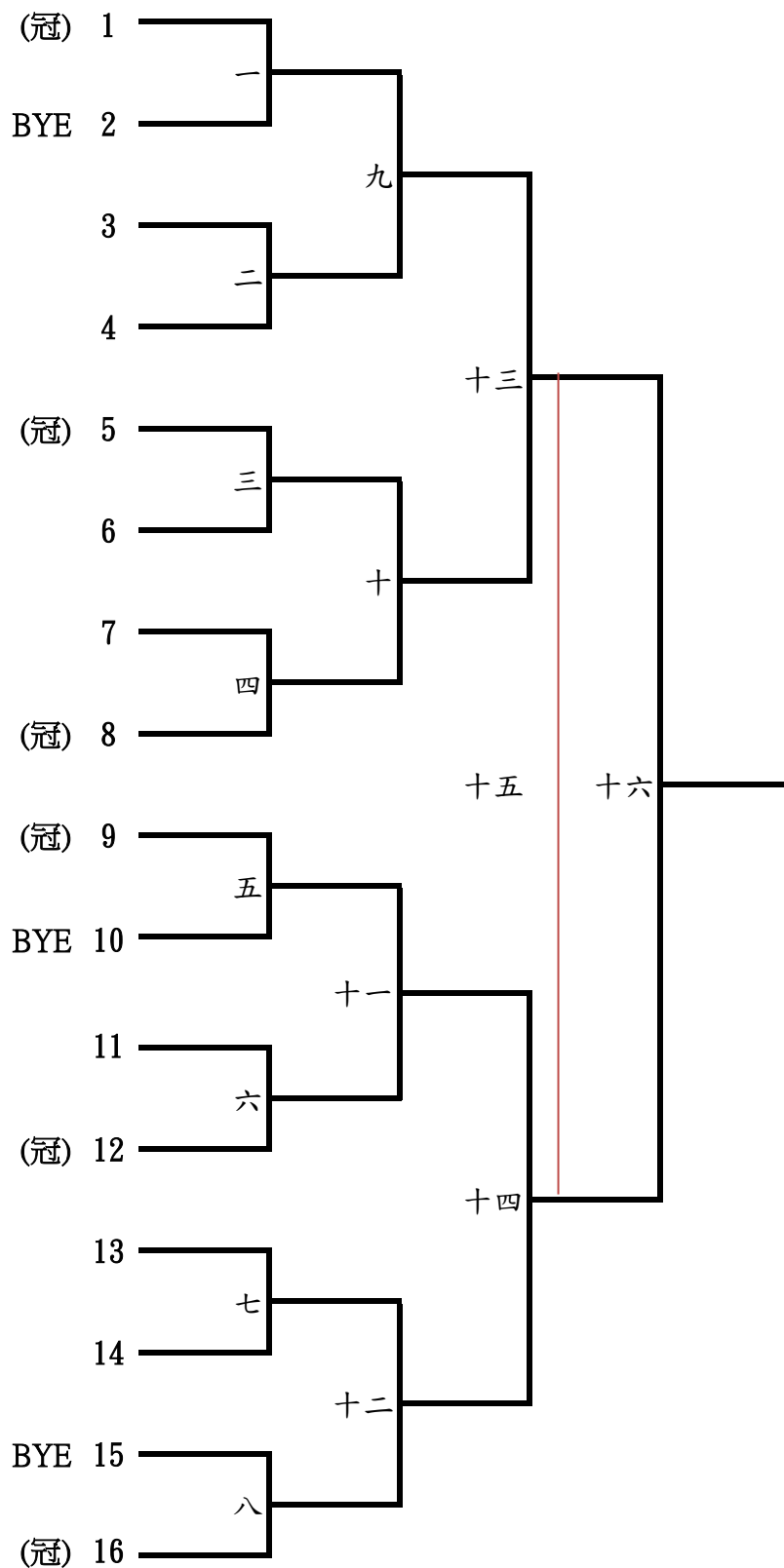

國小女一.二.三.四年級個人預賽，A~D組取兩名E組取三名晉級

1.光復鄉幾赫.汝那.母那烈

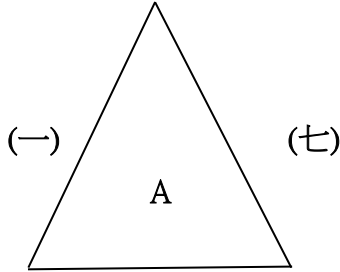

4.玉里鎮黃宥晴

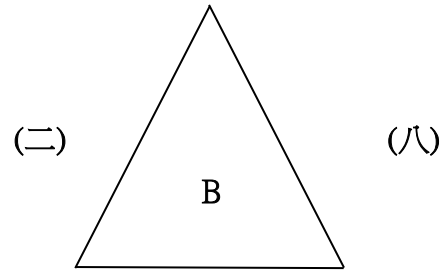

2.吉安鄉鄭芯蓁

(十三)

3.花蓮市彭家語

(十四)

5.吉安鄉邱韶芃

6.花蓮市徐子容

7.吉安鄉蔡家禎

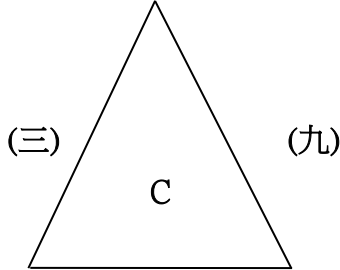

10.花蓮市楊喆甯

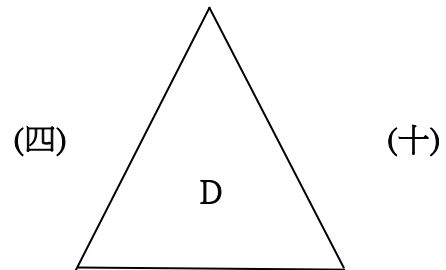

8.花蓮市陳柏妤

(十五)

9.鳳林鎮溫季薰

(十六)

11.吉安鄉邱韶芊

12.鳳林鎮陳蕾合

13.光復鄉曾姿綺

(十一)

14.花蓮市米家樂

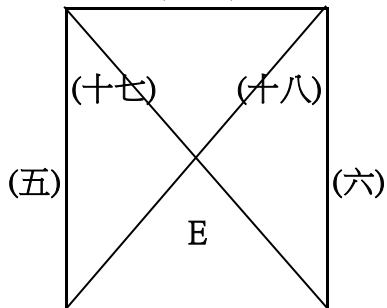

15.玉里鎮陳喬妍

(十二)

16.吉安鄉陳趙好兒

國小女一.二.三.四年級個人決賽(單敗淘汰)

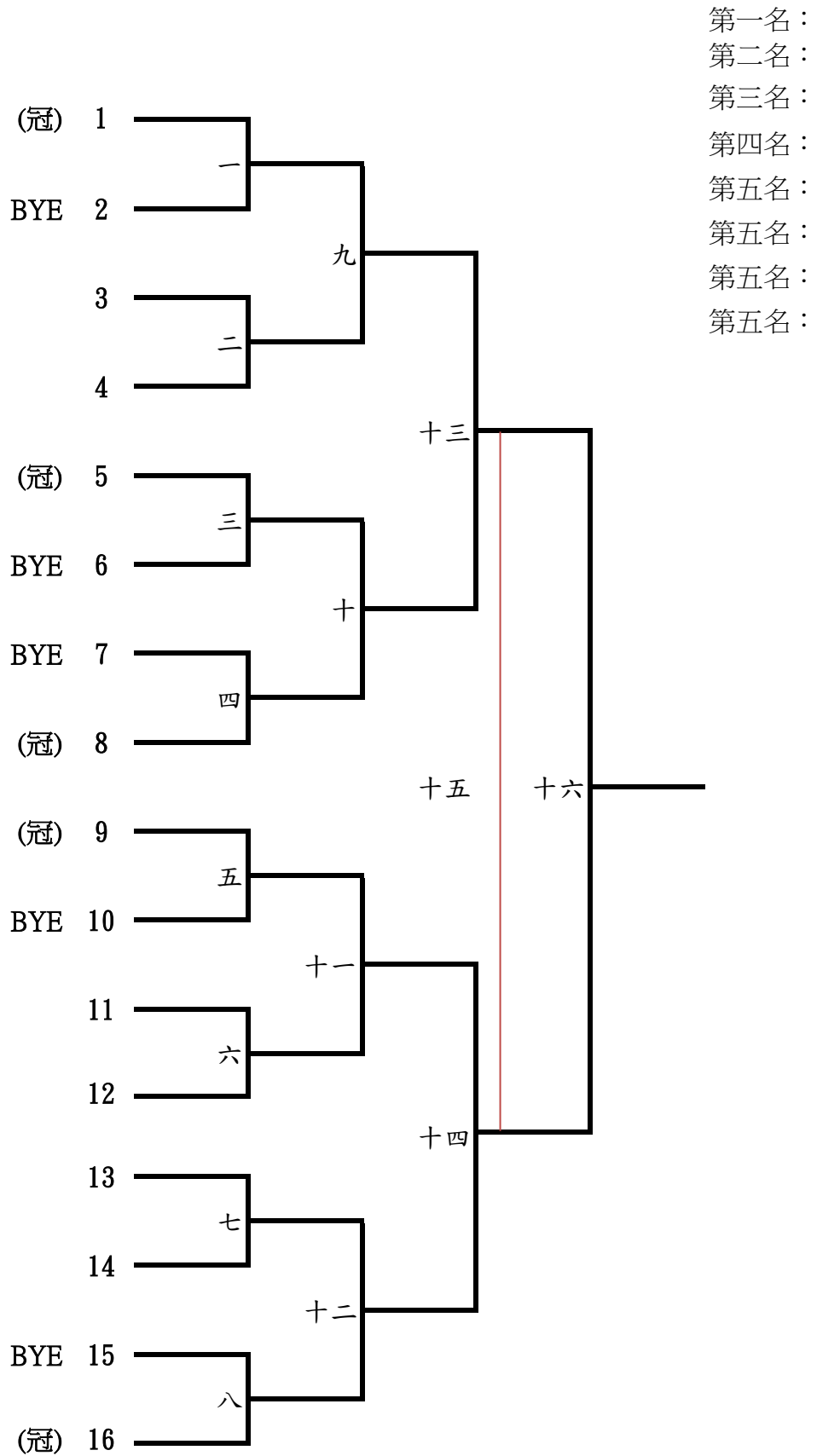

國小男五.六年級個人預賽，A~E組取兩名，F組取三名晉級

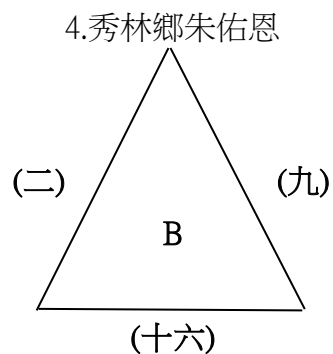
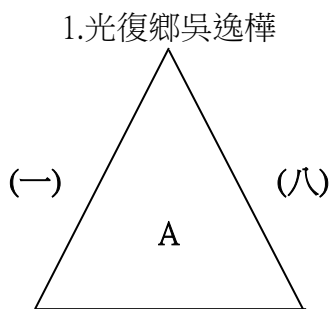

2.秀林鄉陳彥翔 (十五) 3.花蓮市陳宥彰

5.光復鄉鍾仕凱

6.花蓮市江彥柏

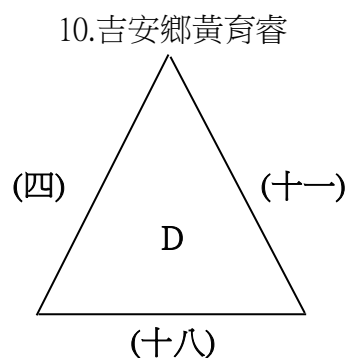
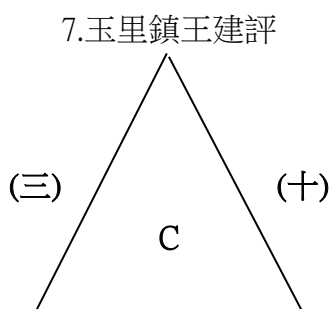

8.吉安鄉江承謙 (十七) 9.秀林鄉金勝榮

11.秀林鄉蕭彥德

12.花蓮市侯定騫

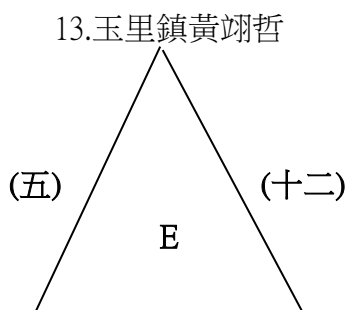

16.秀林鄉金少允 (十三) 17.花蓮市彭駿宇

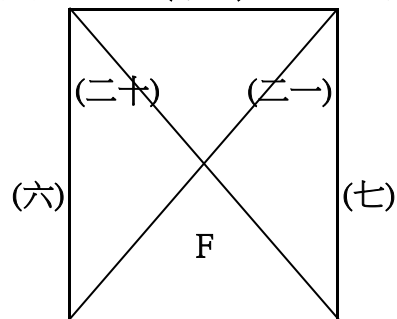

14.花蓮市李書璿 (十九) 15.光復鄉汪于燧

18.玉里鎮陳俊樺

19.吉安鄉鄭凱文

國小男五.六年級個人決賽(單敗淘汰)

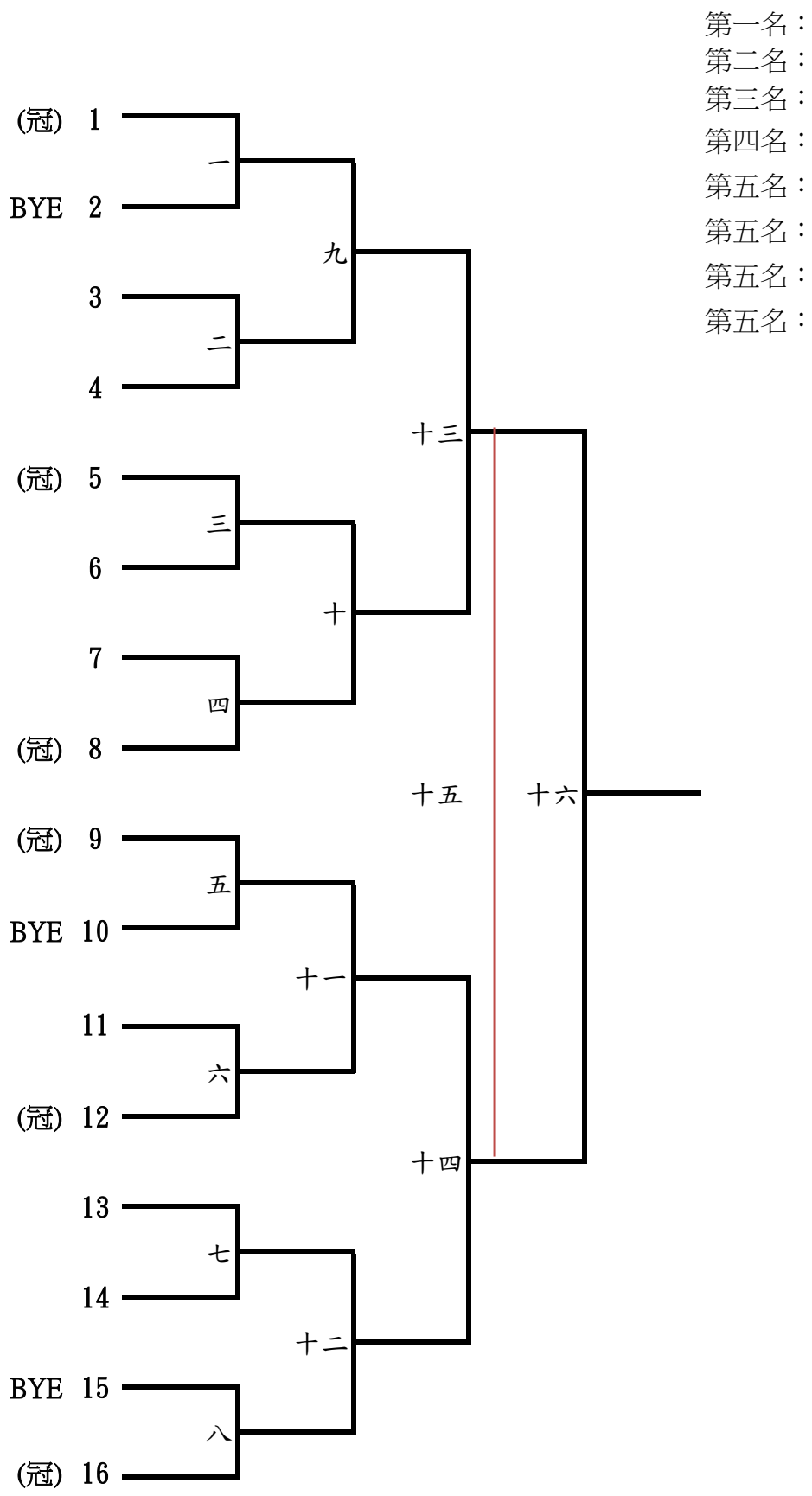

國小女五.六年級個人預賽，A~D組取兩名，E組取三名晉級

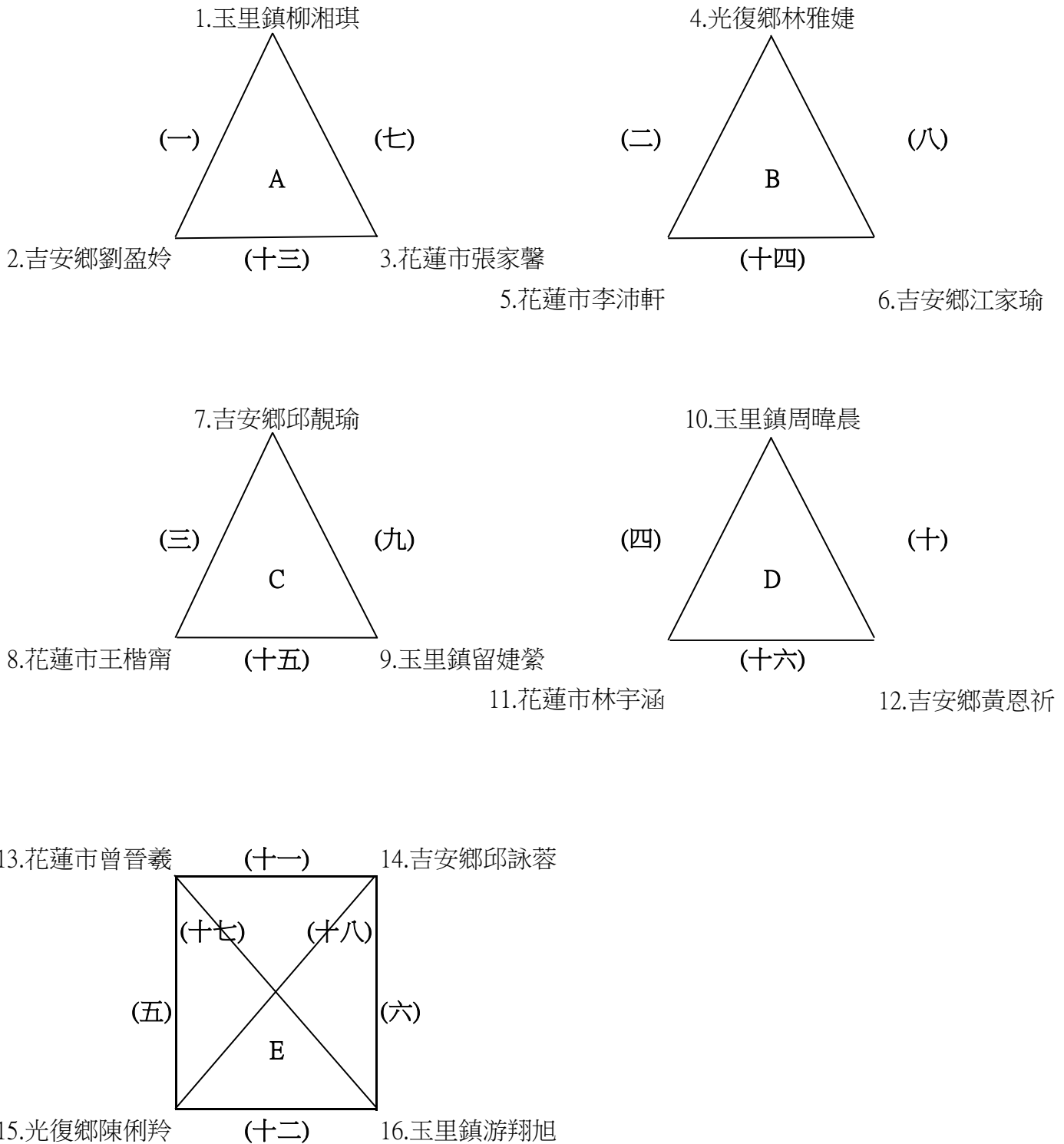

國小女五.六年級個人決賽(單敗淘汰)

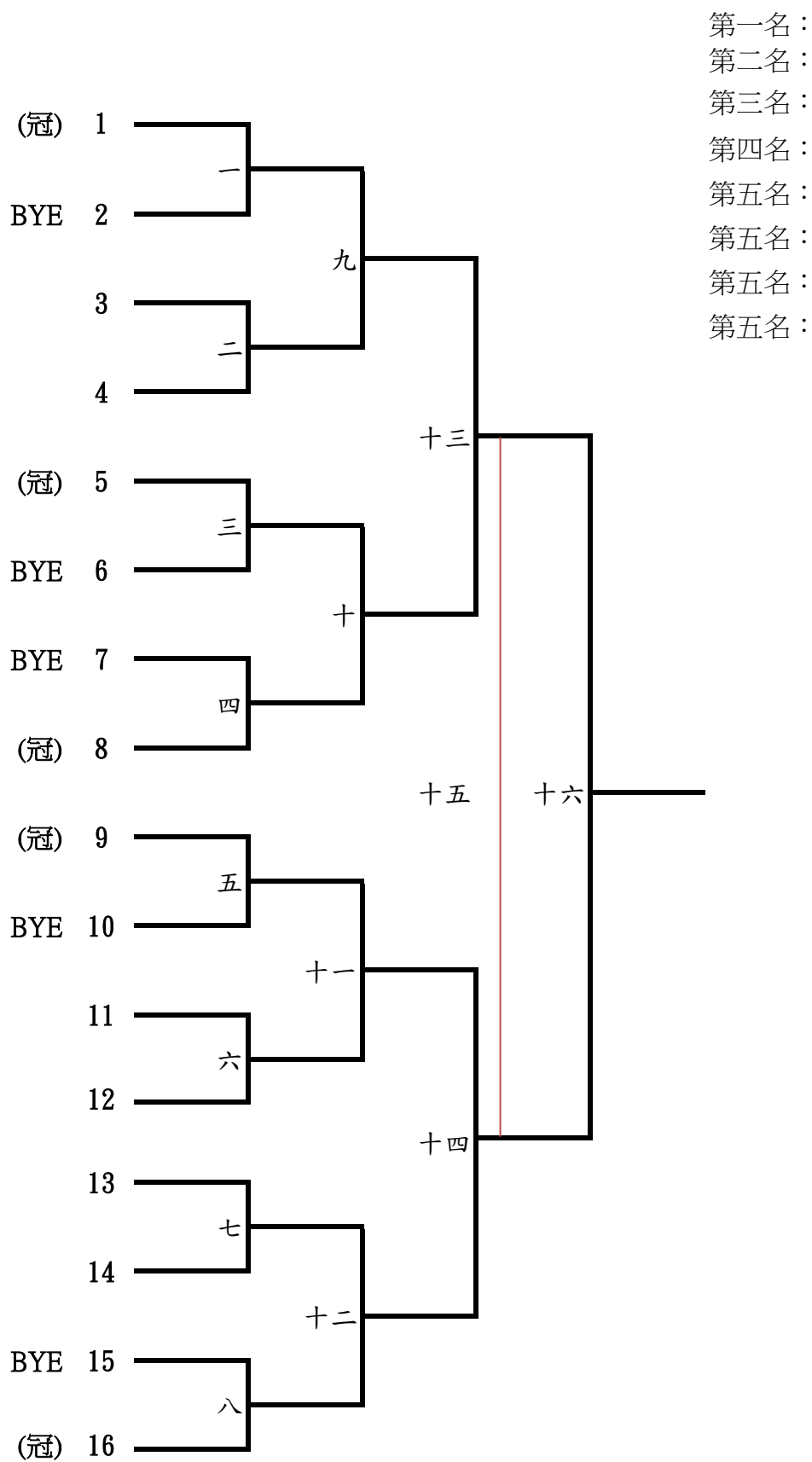

國中男組預賽，A~H組取兩名，I組取三名晉級

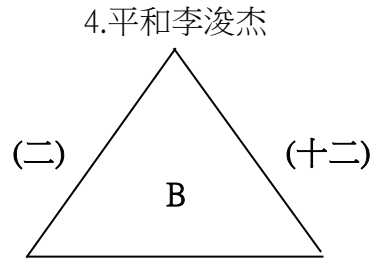
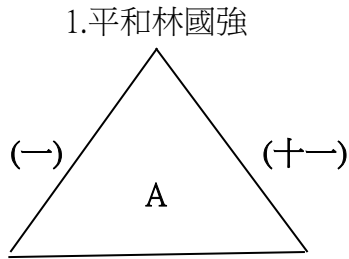

2.花崗黃士軒 (二一) 3.玉里湯翔安

5.美崙黃克皓

6.玉里詹瀚捷

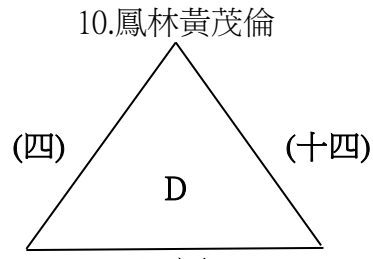
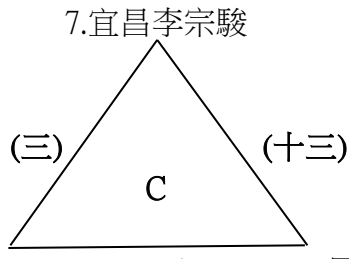

8.花崗李培綸 (二三) 9.鳳林金睿

11.平和冉家臣

12.美崙劉坤元

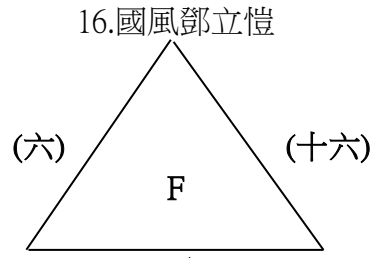
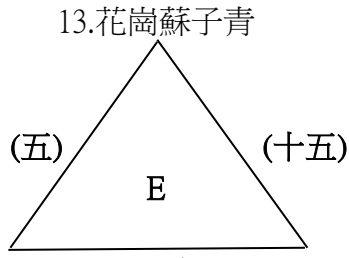

14.國風程星竣 (二五) 15.玉里留羽綸

17.鳳林謝和君

18.平和陳冠宇

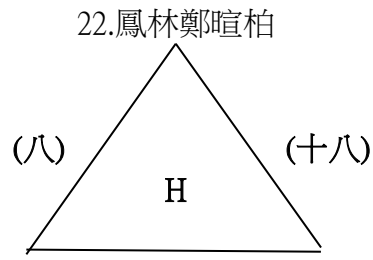
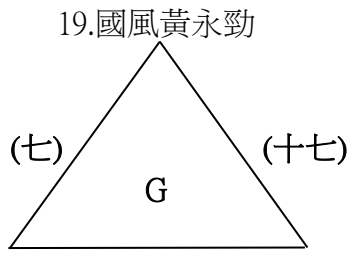

20.花崗古聖璋 (二七) 21.美崙羅紹齊

23.平和蔡昊展

24.美崙崔鎮安

25.鳳林田曜

(十九)

26.玉里呂威

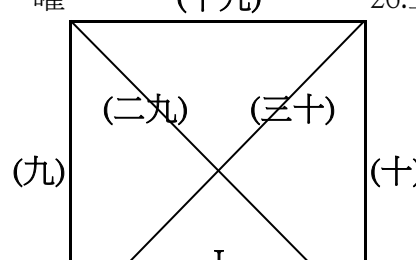

27.美崙涂語謙

(二十)

28.花崗林子恩

國中男個人決賽(單敗淘汰)

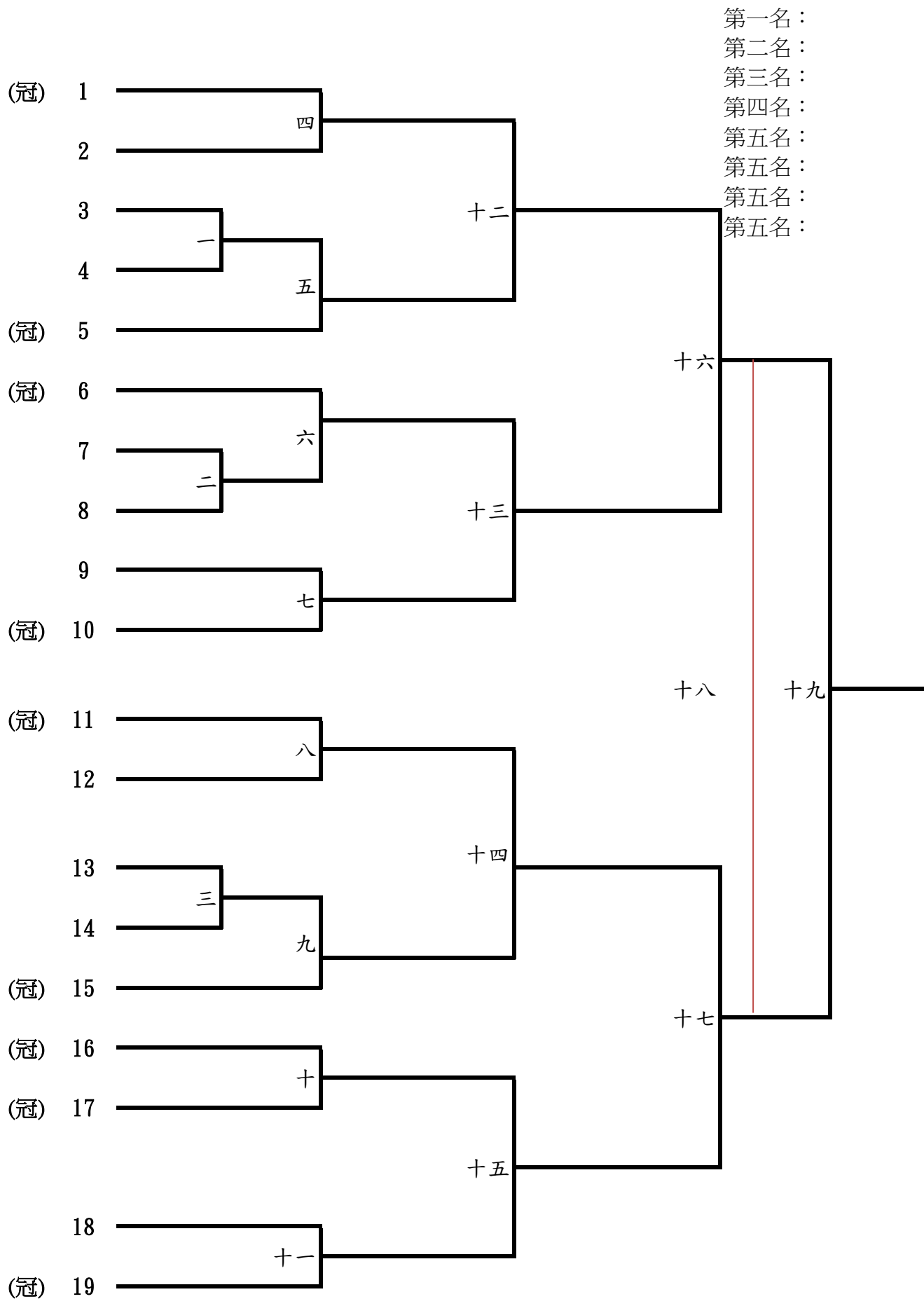

國中女組預賽，A~B組取兩名，C組取三名晉級

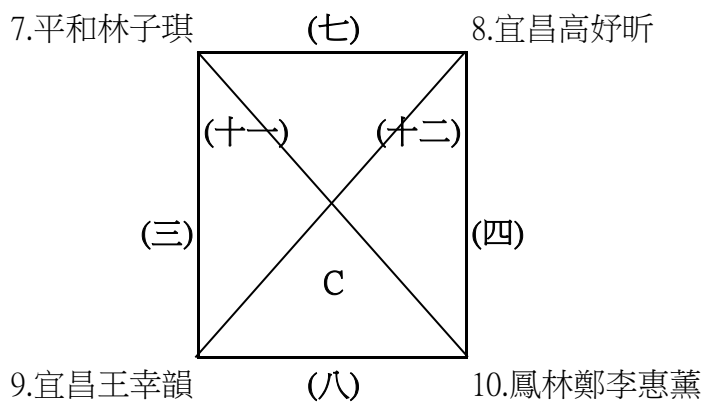
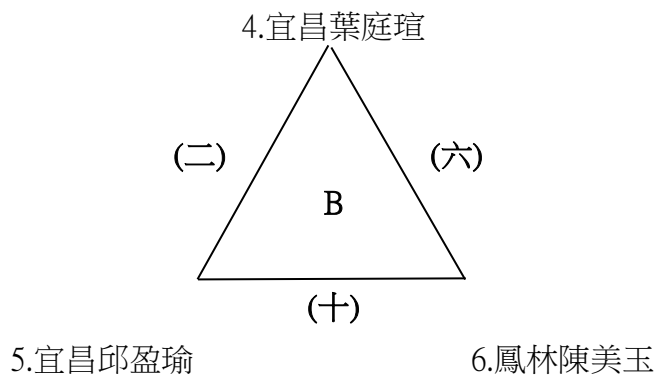
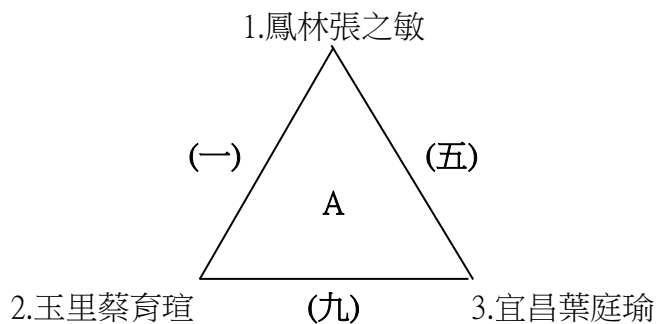

國中女個人決賽(單敗淘汰)

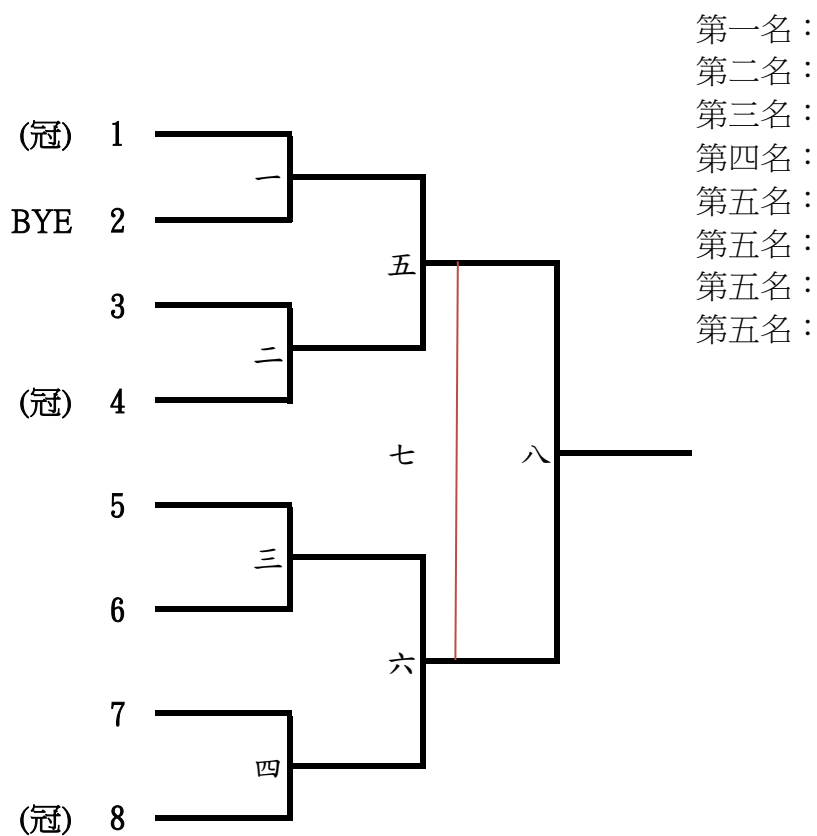

社高男團體組預賽，A~B組取兩名，C組取三名晉級

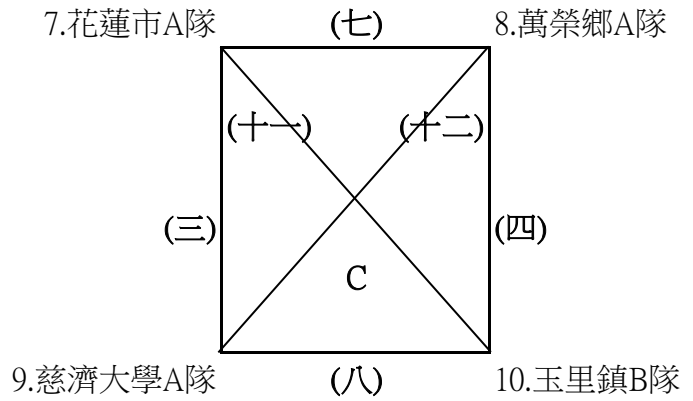
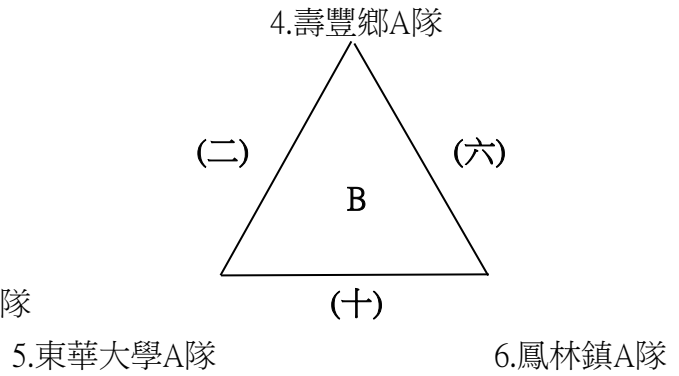
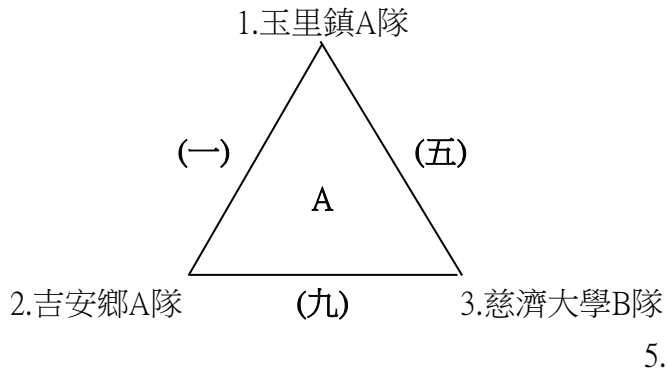

社高男團體組決賽(單敗淘汰)

第一名：
第二名：
第三名：
第四名：

